

DESCRIPTION	444	464	494	4124
LIFTING BAIL	3242	3243	3244	3245
BAIL PIVOT BOLT	3250	3250	2678	2678
BAIL PIVOT BOLT NUT	1761	1761	3065	3065
BAIL PIVOT BUSHING	3246	3246	3247	3248
BAIL PIVOT BOLT WASHER OUTER	0203	0203	0274	0274
BAIL PIVOT BOLT WASHER INNER	0203	0203	1220	1220

DESCRIPTION	444	464	494	4124
BAIL SAFETY BOLT	2704	2704	2703	1626
BAIL BOLT NUT	2245	2245	2245	1181
BAIL BOLT WASHER	2404	2404	2404	2185

PART #	DESCRIPTION
3283	THREAD LOCKING CMPD
2846	GATE LINK TO LEVER
2838	LOWER LEVEL PIVOT PIN
2837	LEVER EYE BOLT
2836	GATE LEVER
2835	GATE PLATE ASSY.
1815	GATE HINGE PIN BUSHING
1476	GATE HINGE BOLT
1442	COTTER PIN
1278	UPPER LEVER PIVOT BOLT
0913	LOCK NUT
0031	HEX NUT

WHEN ORDERING PARTS, SPECIFY:

1. THIS DRAWING NO: 01-56
2. PART NUMBER
3. QUANTITY
4. DESCRIPTION

LIFTING BAIL

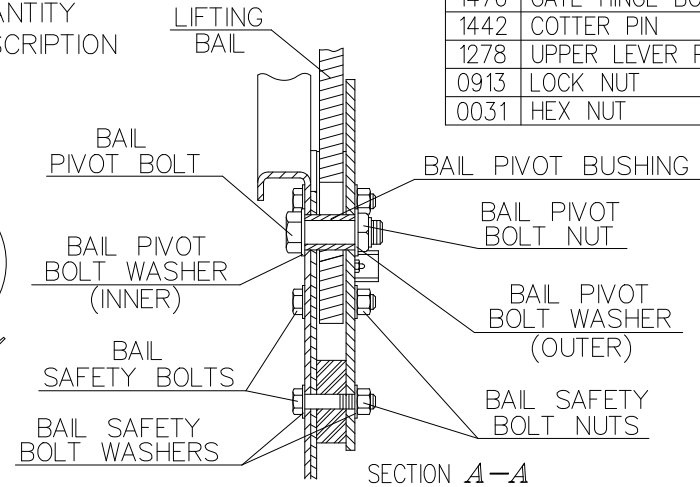
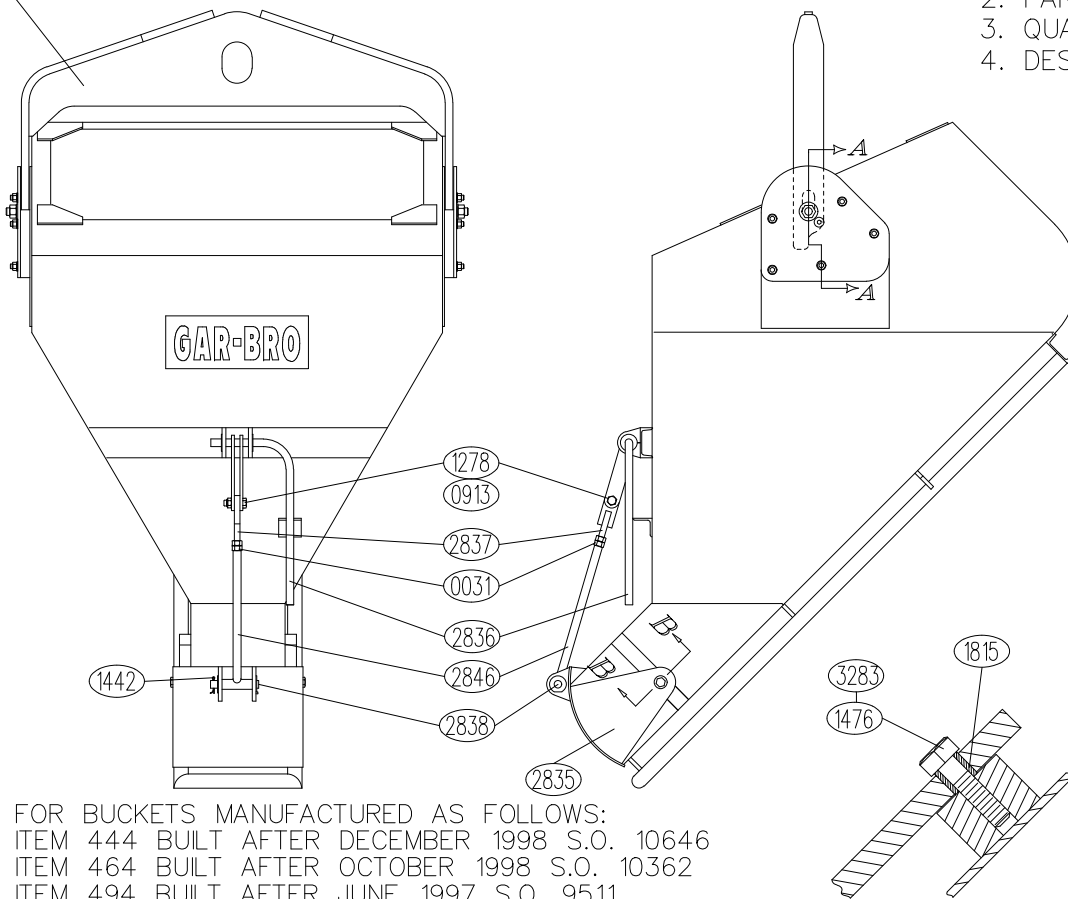

SECTION A-A

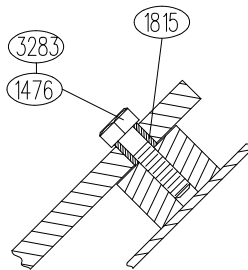

SECTION B-B

FOR BUCKETS MANUFACTURED AS FOLLOWS:  
 ITEM 444 BUILT AFTER DECEMBER 1998 S.O. 10646  
 ITEM 464 BUILT AFTER OCTOBER 1998 S.O. 10362  
 ITEM 494 BUILT AFTER JUNE 1997 S.O. 9511  
 ITEM 4124 BUILT AFTER MAY 1999 S.O. 01419  
 FOR ALL OTHER BUCKETS, SEE DRAWING 76-24

GAR-BRO MANUFACTURING CO.  
 104 BOLTON SULLIVAN DRIVE P.O. DRAWER 1077  
 HEBER SPRINGS, ARKANSAS - 72543-1077

**ITEM 444 THRU. 4124  
 LIGHTWEIGHT EXTENDED  
 GATE LAYDOWN BUCKETS  
 WITH NEW STYLE BAIL  
 PARTS LIST**

SCALE	NONE	SHOP NO.	SALES
DATE	7-9-01	SHIPPING CUBICS	
REVISED	9-1-11	DRAWING NO.	
MADE BY	JPA	01-56	
CHANGED TO/FROM			
SUPERSEDES		SHEET	A OF A